

4

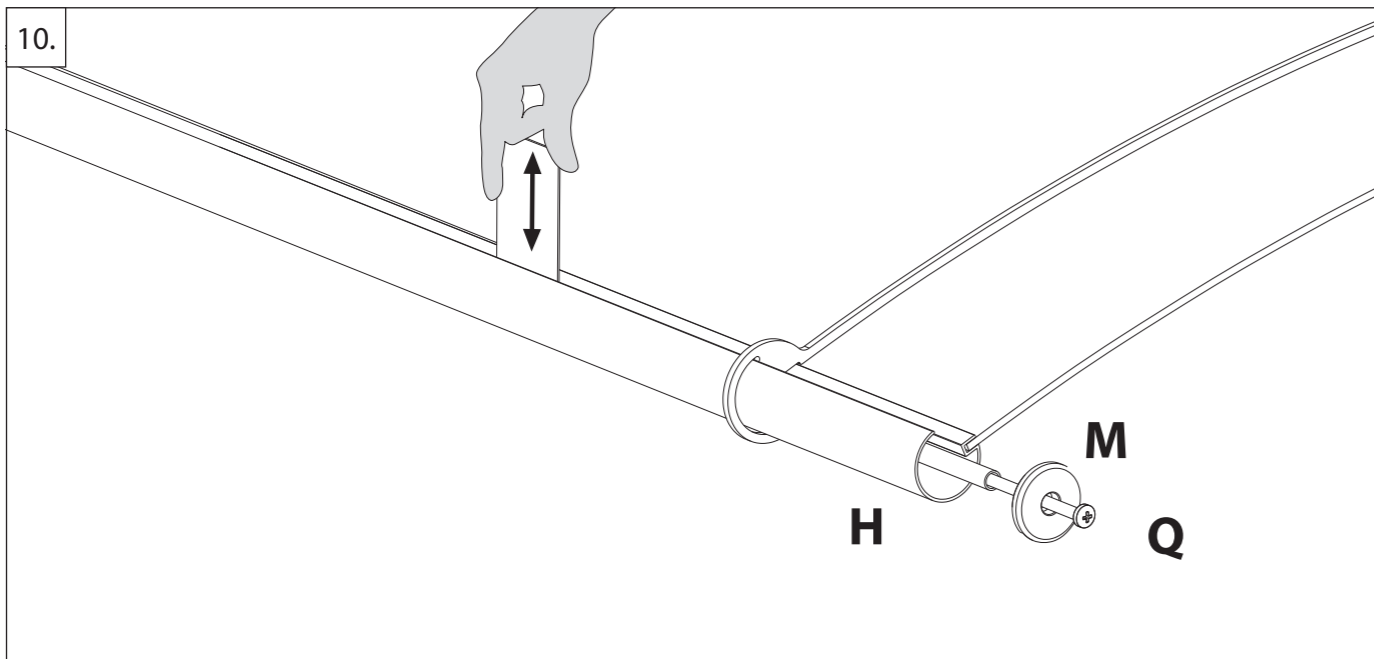

LIGHTLINE®

VORDACH-SYSTEM · CANOPY SYSTEM · SYSTÈME D'AUVENT

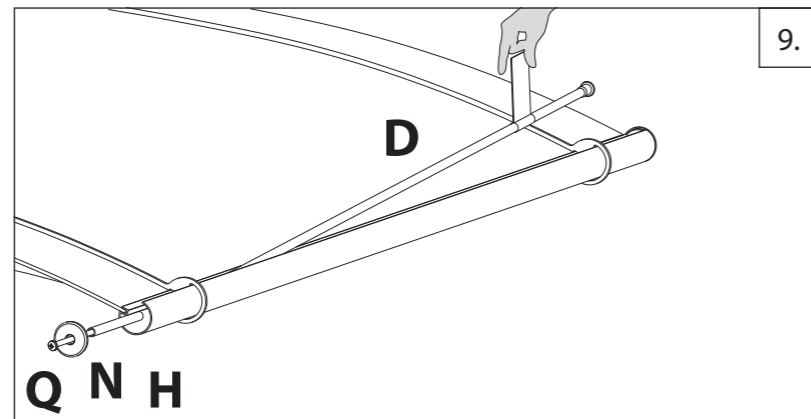
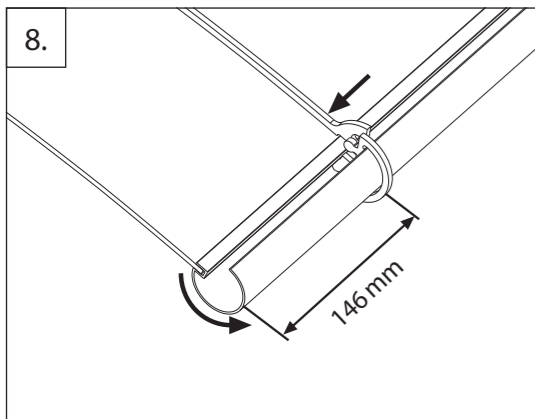
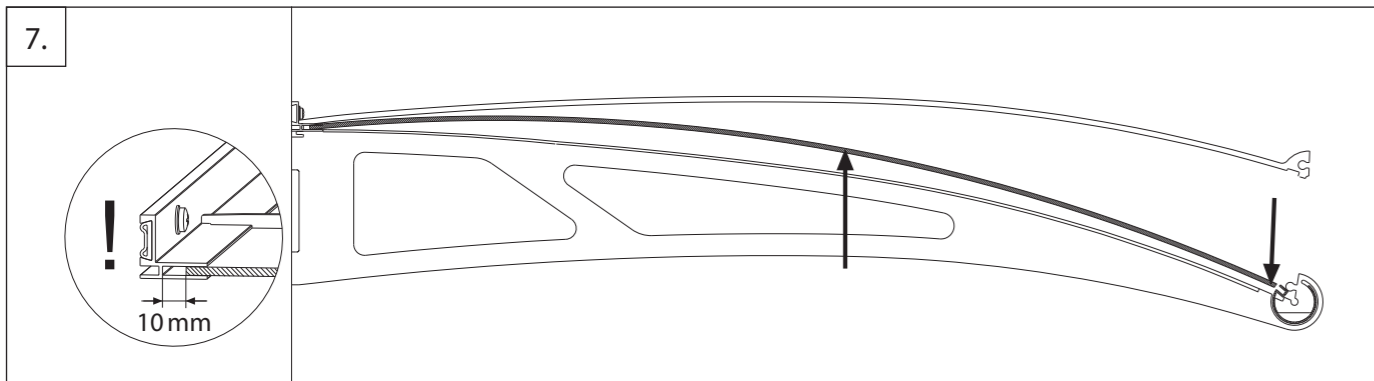
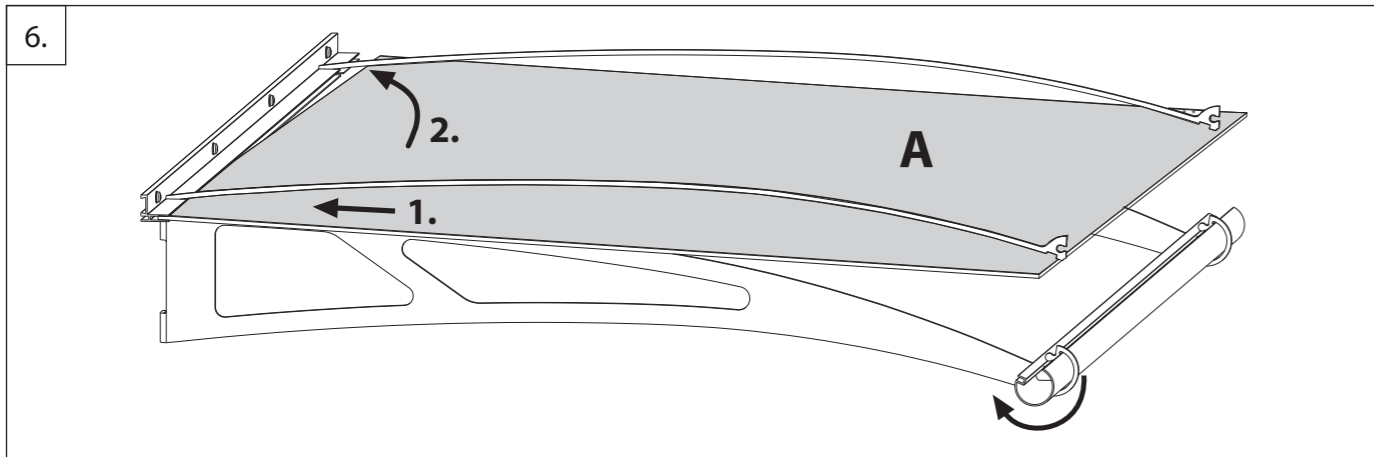



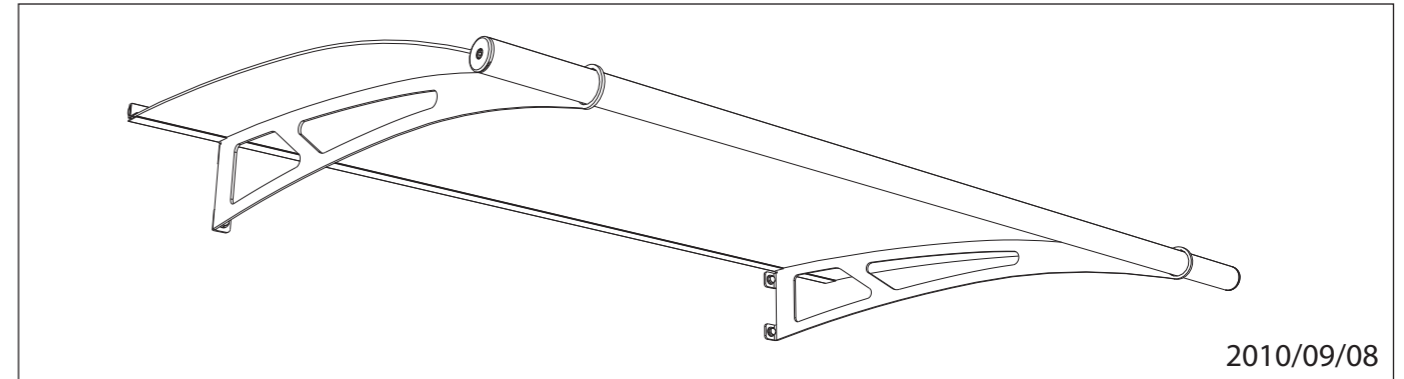



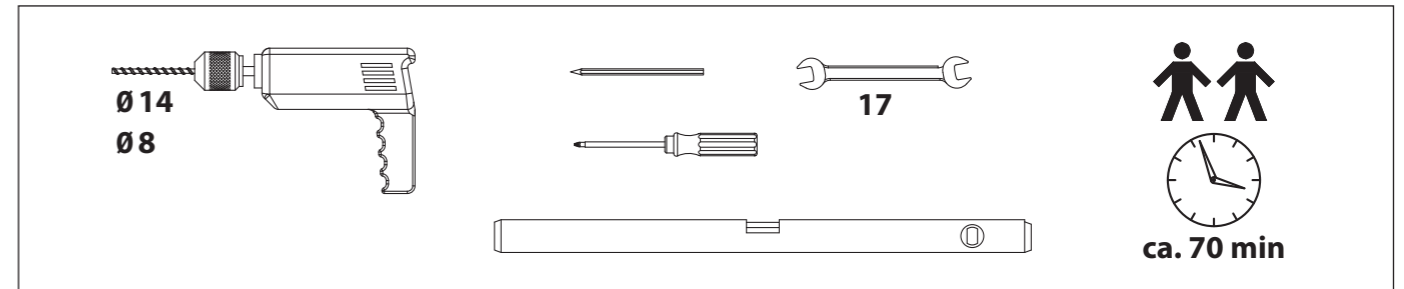

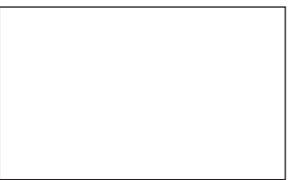
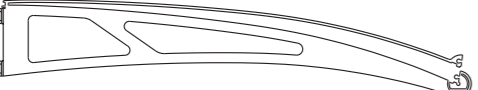



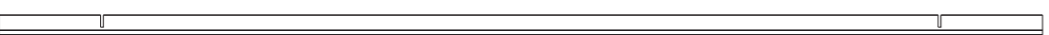



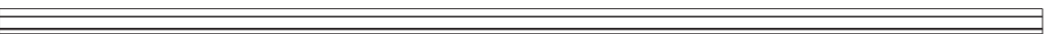

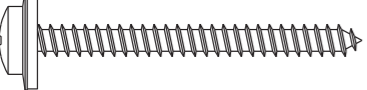
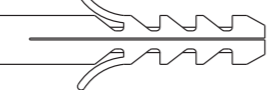
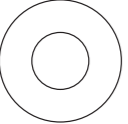

PULTBOGENDACH
ARCHED SHED ROOF
AUVENT PLONGEANT

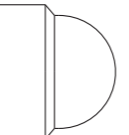
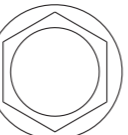
PBD L(W) 1500

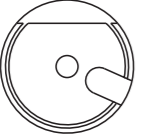

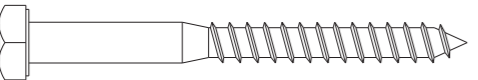
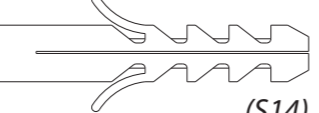
2010/09/08



<p>A  1500x905x4 1x</p>		
<p>B  1x</p>	<p>C  1x</p>	
<p>D   1x</p>		
<p>E   1x</p>		
<p>F   1x</p>		
<p>G   1x</p>		
<p>H   2x</p>		
<p>I </p>	<p>J  4x</p>	
<p>K  </p>	<p>L   4x</p>	
<p>M   rechts <i>right</i> <i>droite</i> 1x</p>	<p>N   links <i>left</i> <i>gauche</i> 1x</p>	
<p>O  (DIN 571 10x100)</p>	<p>P  (S14) 4x</p>	
<p>Q  2x</p>		
<p>T   2x</p>		

