

TESTATO DA

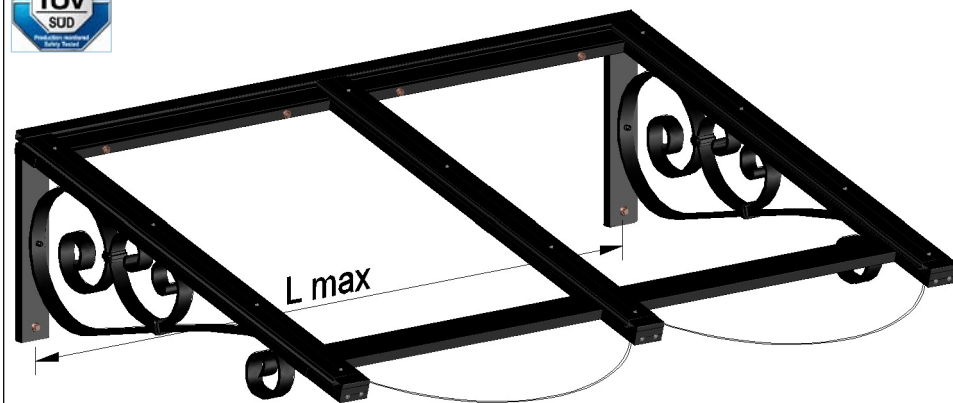

TUTTI I PROFILI SONO REALIZZATI IN ALLUMINIO VERNICIATO A POLVERI POLIESTERE LEGA 6060 STATO T5 o T6 CON UNO SPESSORE VARIABILE TRA 1,5 - 2 mm. (scala 1:2)

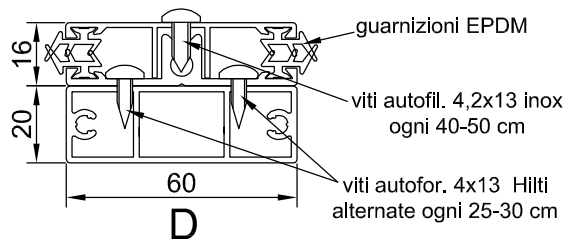
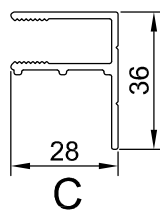
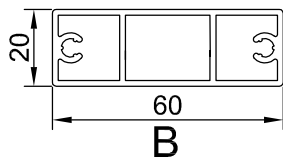
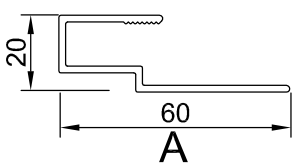

RICCIOLI IN ALLUMINIO LEGA 6060 DI SEZIONE 37x8 mm. (scala 1:10)

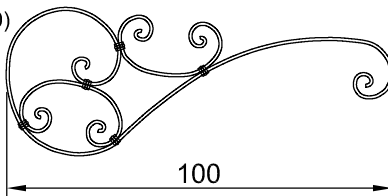
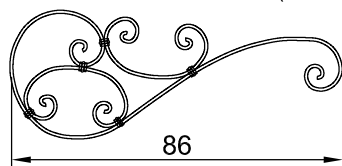
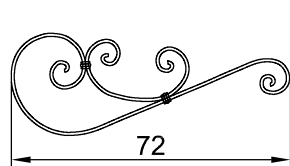

CODICE	S cm	L max cm	Area mq	H cm	h cm	Ricciolo cm
LB110	110	170	1,87	31	40	72
LB120	120	170	2,04	33	40	72
LB130	130	170	2,21	36	48	86
LB140	140	160	2,24	39	48	86
LB150	150	150	2,25	42	55	100

CODICE		DATA 24/04/12	PROFILI ALLUMINIO ESTRUSO ALLUMINIO 6060 STATO T5 o T6
DESCRIZIONE LBxxx		SCALA ---	LASTRE DI COPERTURA POLICARBONATO COMPATTO SPESS. 4 mm.
PENSILINA LIBERTY S 110-150		GUARNIZIONI EPDM	APPROVATO
REV.	DESCRIZIONE REVISIONE	DATA	<p>VIA SCHIAVONIA 76 - 31022 PREGANZIOL (TV) 0422 - 331577 - WWW.TECHIN.IT - INFO@TECHIN.IT</p>
06	----	----	
05	----	----	
04	----	----	
03	----	----	
02	----	----	
01	----	----	
00	PRIMA EMISSIONE DEL DISEGNO	24/04/12	